

MPPT Solar Charge Controller

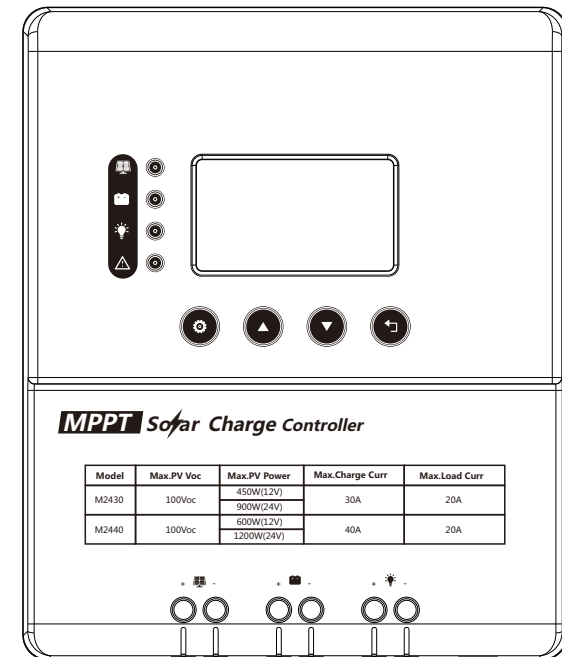







M2420/M2430/M2440

User Manual



Any versions could be revised without prior notice

Marks & Tools Suggestion

Marks & Tools	Item	Description
	High Voltage Danger Mark	High voltage might exist in the controller, and all operations ought to be made by electrical professions.
	Heating Caution	Keep distance with the controller, due to probable heating when it's working.
	EU WEEE Mark	Don't litter the controller as trash.
	Wire Stripper	For wire stripping.
	Multiply Meter	To check the positive/negative connection, and to check current or other electrical value.
	Anti-static Glove	To avoid controller damage caused by static electricity from human body.
	Electrical Tape	To tape the wiring joint for safety reason.
	Screwdriver	To fix the screws.

Safety Use Tips

- Please be cautious of AC grid power nearby in installation or use of solar charge controller.
- The PV voltage may exceed the value of the human safety voltage, so only professions are allowed to install, test, and use this solar charge controller.
- Please be cautious of the sparks that maybe made while wiring.
- Please never short circuit the battery or battery banks. It's better to add fuses in battery wiring.
- If there is any request on adjusting the battery voltages, please follow the proper voltage settings or advise the professions. Any wrong voltage settings may cause damages to battery or controller.
- Please make sure no children would get close to the installation position of the system. Don't let children touch any part of the system.
- Please double check the fixtures to make sure the installation is handled well.
- Please select the suitable cable/wire for solar charge use. Here at below you can check the minimum cable sizes required according to different current involved.

CURRENT	5A	10A	20A	30A	40A
wire cross section area mm ²	1.5	2.5	5	8	10
wire AWG	15	13	10	8	7

Product Features

Thanks for using our product. This solar charge controller is typically a device for solar charge regulation and discharge output control, adopted the latest MPPT charge algorithm technology for max use of solar power. LCD screen display, parameter settings allowed, mainly used in small and medium size solar DC power system.

- a) Multiply MPPT charge algorithms combined for better use of solar power, ensuring the best charge efficiency under different environments and weathers.
- b) Capable of checking different peak points with different power in the PV array, to make sure the system is not running at a lower power peak point.
- c) Allow max input power with 1.5 times of rated value, and keep the controller charging on the rated power with no damage.
- d) MPPT, boost, equalize, & float charge modes in different charge stages.
- e) In the DC load end (20A), with soft starting technology, it' s capable of starting max 80000uf capacitor or load in equal.
- f) Most types of battery can be supported and selected, like AGM (or other sealed type), GEL, Flooded, and Lithium battery (with various voltage settings), by key setting in the controller.
- g) 12V/24V battery system auto recognition for lead-acid type battery or non-lithium type battery.
- h) In no-charge time, the controller will standby in a low power self-consumption mode, with very little power loss.
- I) LCD screen, displaying system working status and setting parameters.
- j) User-friendly key press operation, simple and easier.
- k) RS485 communication, Modbus protocol adopted.
- l) Supports max 100 days' data record in the backstage system (charge power amount, discharge power amount, max charge power, max battery volt, lowest battery volt, etc)
- m) Multiply output control mode selection: light control mode, light + time control mode, test & debug mode, manual mode, and always-on mode.
- n) Industrial grade design, for better function under extreme environment conditions.
- o) Full range of electrical protections, like anti-connection in PV and Battery wiring, load short circuit, battery over-discharge, system over voltage, controller over heating, and etc.

Product Illustration

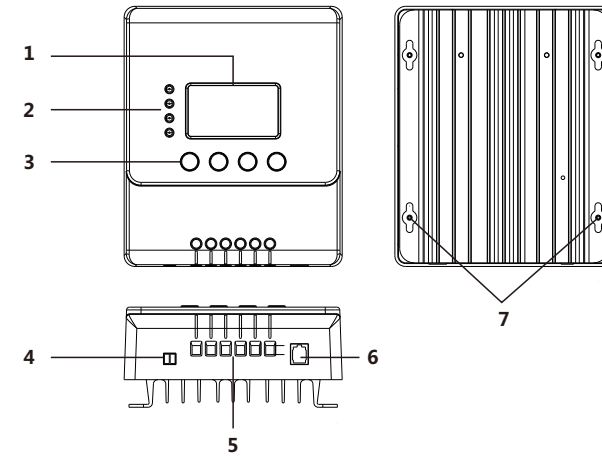

1	LCD Display	5	Connection terminals (PV , BAT , Load)
2	LED Indicator (PV,BAT,Load,Fault)	6	RS485 communication port
3	Function Key(SET 、 UP、 DOWN、 ESC/Load on/off)	7	Installation hole
4	Port for external temperature sensor		

Installation Instruction

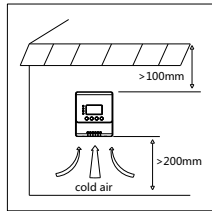

Step 1: To find a proper place for installation (with no direct exposure to sunlight or raindrops)

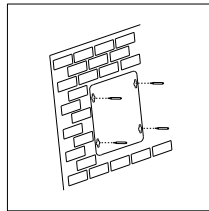

Step 2: To mark the mounting holes in the installation surface, against the holes left in the paper card.

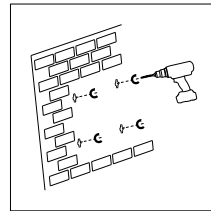

Step 3: To drill 4 mounting holes on the marks.

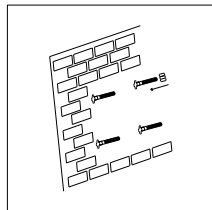

Step 4: To fix the pilot screws or pins in the mounting holes.

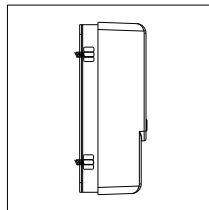

Step 5: To fasten the controller in the pilot screws or pins.

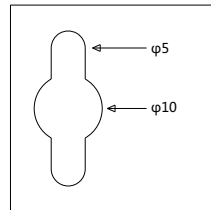

Step 6: To do the wiring job.

Wiring Sequences

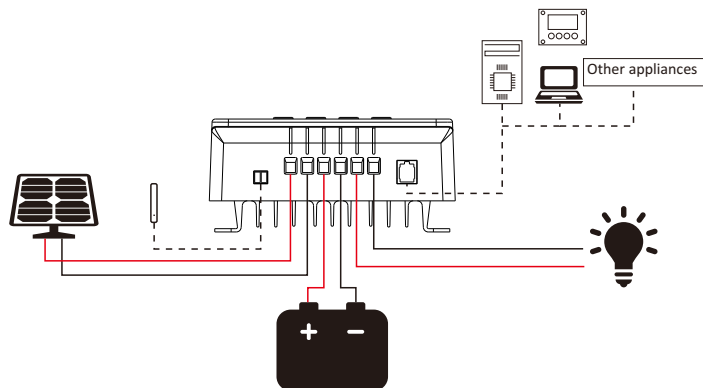

First: Connect the battery first, please choose cable accordingly.

Second: Connect the solar panel

Last: Connect the load wiring to the load (if necessary)

RS485 Ports(RJ12) Instruction

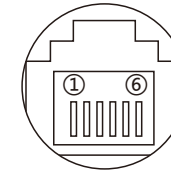













RS485 PIN					
PIN-1	PIN-2	PIN-3	PIN-4	PIN-5	PIN-6
VDD	VDD	GND	GND	D+	D-

LED Indicator Instruction

Led Indicator	Indication	Description	
PV	PV Status	Off	No charge - at night time or wrong PV connection (to check fault indicator)
		Double-flash	At day time but not charge yet
		Single-flash	PV anti-connection !
		Steady On	In MPPT charge
		Fast Flash	In equalize or boost charge
		Slow Flash	In float charge
BAT	Battery Status	Single-flash	Battery anti-connection !!
		Fast Flash	Battery over voltage
		Slow Fast	Battery over discharged
		Steady On	Battery status is ok
LOAD	Load Status	Off	Load is off
		Fast Flash	Load short circuit !
		Steady On	Load is on
FAULT	Fault Info	Off	System OK
		Steady On	System errors !



Installation Instruction

Flash Status	Indication	Description
Steady on	ON  OFF 	Indicator keeps on
Off	ON  OFF 	Indicator keeps off
Fast Flash	ON  OFF 	Indicator lights on & off at frequency of 20Hz
Slow Flash	ON  OFF 	Indicator lights on & off at frequency of 0.5Hz
Single-flash	ON  OFF 	Indicator lights off 2 seconds and off 0.1 second in circles
Double-flash	ON  OFF 	Indicator lights off 4 seconds, on 0.1 second, off 0.1 second, on 0.1 second in circles

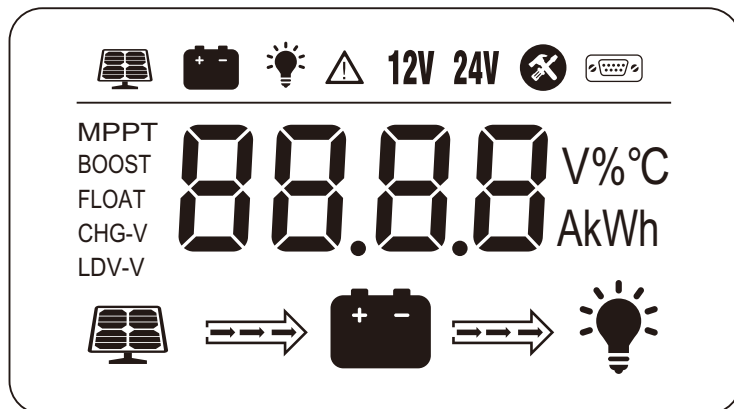



LCD Display Indication



Status Icons Sections

Item	Description	Status
Status	Current system working status	
Parameter	Parameter value for selected item	MPPT BOOST FLOAT CHG-V LDV-V 
Selected Item	Current selected item	

Status Indication

Status Icon	Indication	Status	Description
	Charge Indication	Floating	In charge
		Off	No charge
	PV Indication	Steady On	PV volt higher than light control volt
		Off	PV volt lower than light control volt
		Fast Flash	PV system over voltage
MPPT	Charge Status	Steady On	In MPPT charge
BOOST			In Boost charge
FLOAT			In Float charge
CHG-V	Charge Volt Settings	On	In setting of charge voltage
		Off	-
LDV-V	Over Discharge Volt Settings	On	In setting of over discharge voltage
		Off	-
	Battery Indication	Steady On	Battery status OK
		Off	No battery connection
		Fast Flash	Battery over discharged
	Discharge Indication	Floating	In discharge
		Off	No discharge
	Load Status	Flash	Over loaded or load short circuit

Display Information Float

1. Wait for device starting

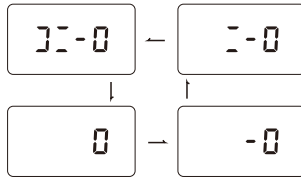

2. Enter the system pages in circles displaying

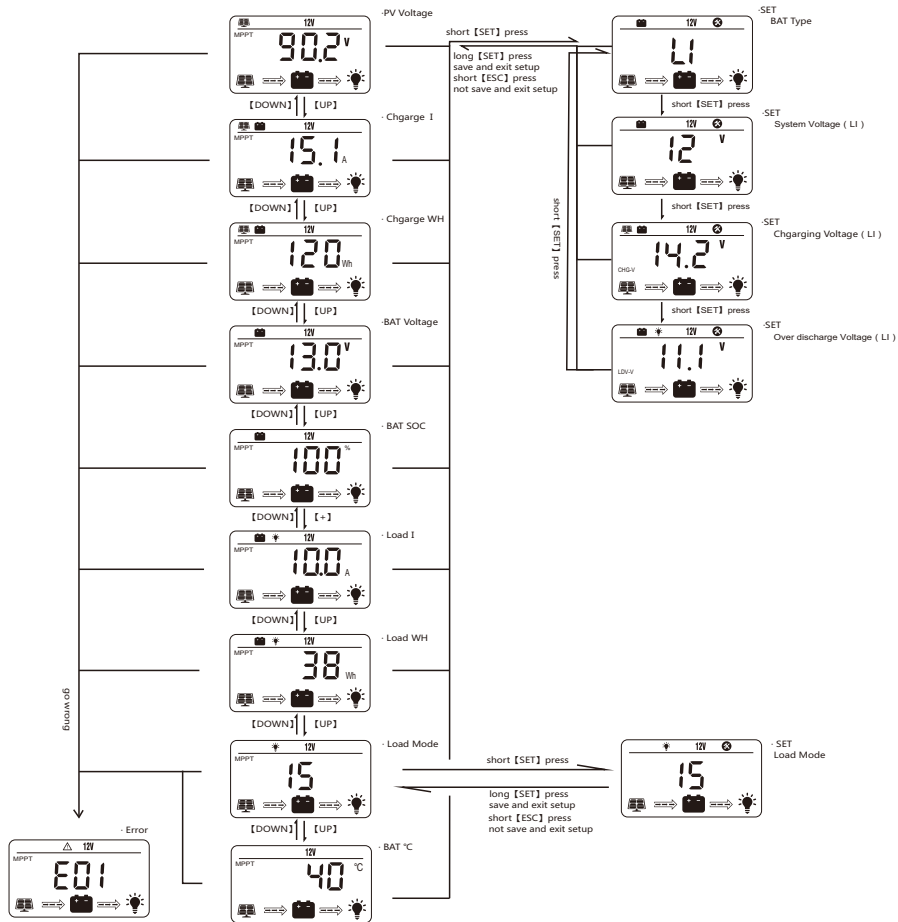

Remarks:

- *The page will enter to the next one if no operation in 3 seconds
- *The system will automatically enter to the "error" page when there is an error detected. This page will stay still until the user operates in the controller to enter to the other pages.

Press Key Operation

Key	Funtion Status	Operation	Operation Indication
	In Setting	Long Press	Exit from setting & saving the present settings data
		Short Press	Enter the next setting page
	Not in Setting	Long Press	-
		Short Press	Enter setting
	In Setting	Short Press	Adjust the parameter by increase the value
		Not in Setting	Short Press
	In Setting	Short Press	Adjust the parameter by decrease the value
		Not in Setting	Short Press
	In Setting	Short Press	Exit from setting page
		Not in Setting	Short Press

Remark: "In setting" means the user is setting the new parameters.

BATTERY TYPE & PARAMETER SETTINGS

Battery Type Setting

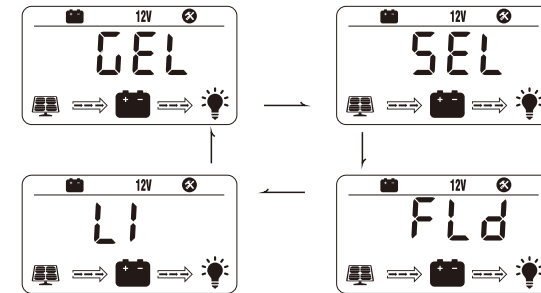

ITEM	BATTERY TYPE	DESCRIPTION
FLD	Flooded battery	Battery system voltage auto recognition; parameters default set.
SEL	Sealed/AGM battery	
GEL	Gel battery	
LI	Lithium battery	System voltage, charge/discharge parameters adjustable

System Voltage (For Li battery only)

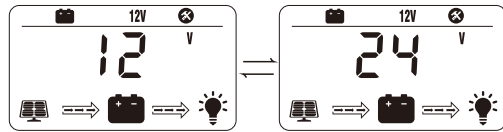

Charge Voltage Settings (For Li battery only)

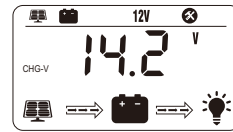

Over-discharge Voltage Settings (For Li battery only)

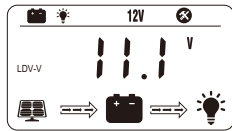

Load Mode Settings

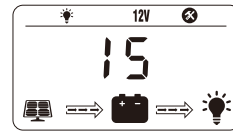

Error Codes



CODE	ERROR	ANALYSIS	RECOVER SOLUTION
E00	No error	-	-
E01	Over-discharged	The battery voltage has been discharged to a low level, load cuts off	Recover once the battery voltage return to the normal level. Load is allowed to turn on then.
E02	Battery over voltage	The battery voltage has exceeded the max level.	Recover once the battery voltage return to normal level.
E04	Load short circuit	The load gets short circuited	Check the wiring and loading condition.
E05	Load over loaded	The load power has exceeded the rated value	Check and decrease the load power requirement.
E06	Device over heating	The controller gets too hot in high temperature, the charge cuts off	Get the device cooler to decrease the temperature
E08	Charge power over rated	The input power has exceeded the max rated value	To decrease the input power
E10	PV over voltage	The PV input voltage is too high	To decrease the input voltage
E13	PV anti-connection	The PV side has anti-connection	Check and re-connect the PV wires in right position
E14	Battery anti-connection	The battery side has anti-connection	Check and re-connect the Battery wires in right position

Specification

* Remark "n" : when system voltage is 12V, n=1; when system voltage is 24V, n=2

ITEM	PARAMETERS			
Model No.	M2420	M2430	M2440	
System Voltage	12V/24V Auto (FLD/GEL/SLD),12V/24V(manual set for Li)			
No-load Loss	8ma(12V) , 12ma (24V)			
Max PV Input Voltage	< 100V			
Rated Charge Current	20A	30A	40A	
Max PV Input Power	300W/12V 600W/24V	450W/12V 900W/24V	600W/12V 1200W/24V	
Battery Type Selection	FLD	SEL	GEL	LI
Equalize Charge Voltage	14.8V*n	14.6V*n	--	--
Boost Charge Voltage	14.6V*n	14.4V*n	14.2V*n	14.4V*n (adjustable)
Float Charge Voltage	13.8V*n			
Boost Charge Recovery Volt	13.2V*n			
Over Discharge Recovery Voltage	12.6V*n		12.6V*n(auto adjust to the over discharge voltage)	
Over Discharge Voltage	11.1V*n		11.1V*n	
Light Control Voltage	5V (12V system) , 10V(24V system)			
Light Control Delay Time	10s			
Load Modes	light control(dusk-to-dawn), light + time control, debug mode, manual control, steady-on mode.			
Operation Temperature	-35°C ~ +45°C			
IP Protection	IP30			
Net Weight	2050g	2500g	2500g	
Communication	RS485			
Display	LCD			
Operation Altitude	≤ 3000M			
Controller Size	179.3*150.3*70mm	205*170*75.3mm	205*170*75.3mm	

Sizing Information

1:M2420

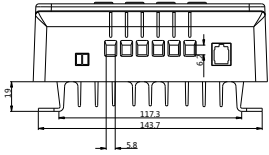

Product Size: 179.3*150.3*70mm
 Installation Size: 130*112mm
 Installation Holes Diameter: 2.3 & 5mm
 Connection Holes Size: 5.8*6.2mm

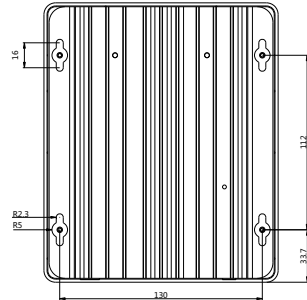
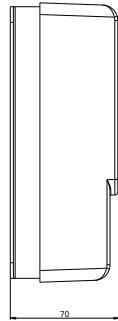
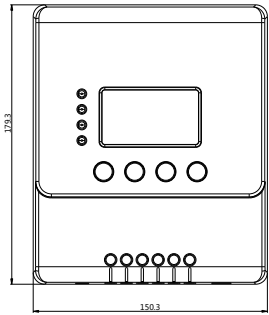

2:M2430 / M2440

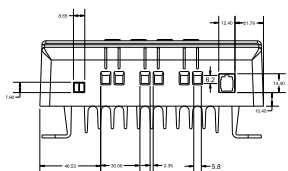
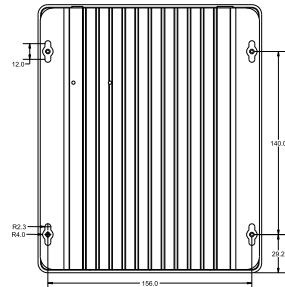
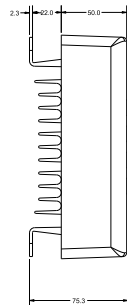
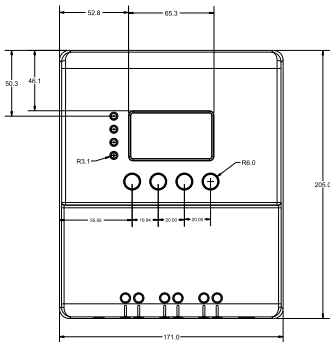

Product Size: 205*170*75.3mm
 Installation Size: 140*156mm
 Installation Holes Diameter: 2.3 & 5mm
 Connection Holes Size: 5.8*6.2mm